

ZW-5A series

HITACHI

Reliable solutions

ZW180



WHEEL LOADER

Model Code: ZW180-5A

Engine power: 128 kW (172 HP)

Operating Weight: 14 370 - 14 860 kg

Bucket ISO Heaped: 2.2 - 3.3 m³

Improved Fuel Economy and Amazing Performance

The new ZW180 wheel loader combines excellent fuel economy with enhanced controllability. The "Active Engine Control System" - original Hitachi technology - determines operating status and adjusts engine speed while suppressing machine jerking. The ZW180 offers what is most needed today - fuel efficiency and productivity.

CONTENTS

10%* fuel saving

* Compared to the conventional ZW180

Page 4 - 5

Fuel economy

Enhanced controllability

Page 6 - 7

Controllability and productivity

Operator-friendly features to improve operator comfort

Page 8 - 9

Operator comfort

Simplified maintenance with proven support system

Page 10 - 11

Maintainability and durability

The New **ZW180** Wheel Loader



ZW Empower your Vision.

A 10% Fuel Saving

The “Active Engine Control System” can reduce fuel consumption by 10%, while enhancing controllability and productivity.



PICK UP Technology to Cut Fuel Consumption

Here are some fuel-saving techniques: avoiding rapid start of travel, and eliminating energy losses during excavation through variable displacement hydraulic pumps.

10%* Fuel Saving

=

Active Engine Control System

+

Quick Power Switch (QPS)
New Transmission

* Compared to the conventional ZW180

NEW Active Engine Control System for Economical Operation and Easy Control



The “Active Engine Control System” plays a key role achieving a 10% fuel saving. Strategically positioned sensors detect movements throughout the machine and adjust engine speed accordingly to eliminate energy losses to maximize fuel conservation. This delivers smooth, fuel-efficient operation.

Active Engine Control System for Digging

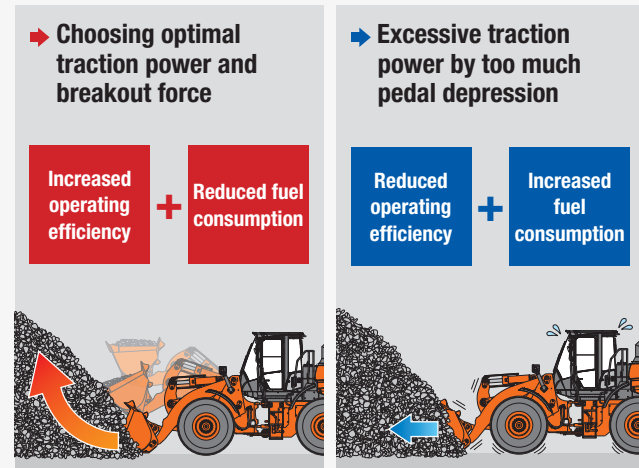

The Active Engine Control System chooses optimal traction power and breakout force for smooth digging while improving fuel efficiency, utilizing data collected from the sensors on the machine.

NEW 2 Selectable Work Modes: Standard and Power Modes



Standard mode is preselected and enough for ordinary work that requires constant power, such as loading. Power mode is selectable when extra power is needed.

A Power Mode

Select this mode when extra power is needed, such as climbing a steep slope or getting the job done quickly.

B Quick Power Switch (QPS)

Pressing the Quick Power Switch on the lever selects the Power mode. When switching forward/reverse, or when a reduction in traction is detected, the Standard mode resumes automatically. The Quick Power Switch helps save more fuel compared to operation when the Power mode is constantly selected.

NEW ECO Mark Indicator for Fuel-Efficient Operation



Monitor indication items:

Clock, oil replacement intervals, travel speed, mileage, hour meter

The ECO mark indicator turns on when fuel-efficient operation is activated. This function encourages operators to utilize fuel-efficient operation.

Enhanced Controllability

Hitachi analyzed various wheel loader operations including digging, approach to a dump truck, operation after dumping and travel. This led to the development of strategies to improve wheel loader controllability.

PICK UP New Transmission with 5 speed gears

The new transmission comes standard with the Auto mode* that can automatically select an optimum gear according to the load, thereby reducing fuel consumption. Especially, the new transmission has 5 speed gears which can keep fuel efficient engine rpm more easily compared to the conventional transmission with 4 speed gears.

* AUTO1 (1st-5th gear) and AUTO2 (2nd-5th gear) are selectable using travel mode selector.



Travel mode selector



NEW Levers for Easy Operation



Fingertip control

Grip control

Two levers

In order to offer more efficient and comfortable operation, a new type of lever is employed to suit both fingertip control and grip control.

* A variety of lever patterns are available depending on job needs and operator's preference.

NEW Speed-responding Clutch Cut-off System



Clutch cut-off timing is adjusted by sensing travel speed and pedal depression for smooth, efficient truck loading. The Flat mode, Slope mode and OFF are selectable by switch control according to job requirements.

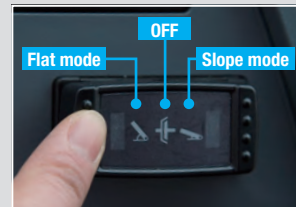

Clutch cut position switch

NEW Shift Change Delay Mode (Optional)

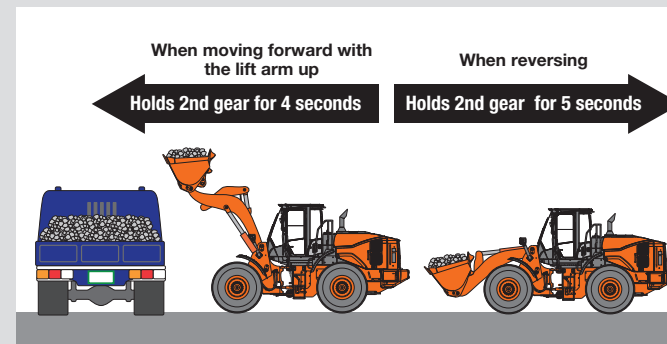

Shift change delay mode is provided to avoid an excessive rise in travel speed during digging and loading. When moving forward with the lift arm up, the second gear is kept for four seconds to prevent over-speed. When reversing, the second gear is kept for five seconds. These delays to third gear help to keep fuel consumption down ensuring smooth loading.

Lift Arm restriction valve

This restriction valve suppresses the shaking of the machine when the lift arm stops to improve operator comfort and avoid load spills.



Lift Arm Auto Leveler (Optional)

The lift arm can be automatically stopped at a preset level for efficient truck-loading, and lowering the bucket after dumping. The operator can concentrate on traveling without worrying about the lift arm.

Operator-Friendly Features to Improve Operator Comfort

The cab is both comfortable and functional with a series of features aimed at reducing operator fatigue.

PICK UP Bi-Level Auto Air Conditioner

This auto air conditioner has bi-level control function: warming at foot space and cooling at overhead. The pressurized cab shuts out dust, keeping the cab interior clean. In dusty environments, optional external double-filters are available for the air conditioner.

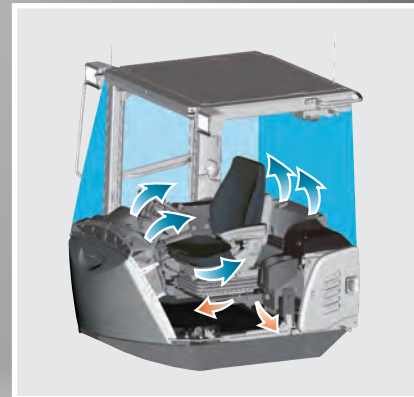

Panoramic Cab



The spacious panoramic cab offers near all-round visibility through pillar-less bonded windows. The seat and steering wheel can be adjusted to suit the operator, keeping the operator in an optimum position. In-cab noise is suppressed further. Even when the going gets tough, the operator can feel comfortable with less fatigue.

Tiltable Steering Wheel

The steering wheel is tiltable to fit the wheel to the operator for comfortable operation.

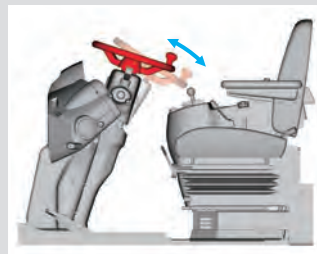

Tiltable steering wheel

Comfort-Designed Suspension Seat

The mechanical suspension seat absorbs shocks and vibration from the machine in order to reduce operator's physical stresses to the operator.

* The air suspension seat is available as an option.



Suspension seat

AM/FM Radio with 2 Speakers

The AM/FM radio has an auto-tuning feature and the 2 speakers stereo system provides excellent sound quality. The player pocket can hold a cell phone.

* An AUX port (stereo mini jack) is an option for connection with a mobile music player for entertainment during breaks.



AM/FM radio with 2 speakers



Player holder

NEW Rearview Monitor (Optional)

The rearview monitor allows the operator to see the rear of the machine, including a view behind the counterweight. This rearview monitor enhances safe operation.

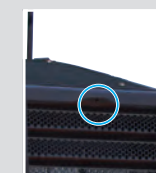

Rearview camera

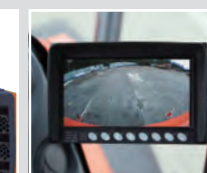

Rearview monitor

An Array of Convenient Accessories



Drink holder



Large storage space



Storage for small items



Hot and cool box



Front defroster



Rear air outlet

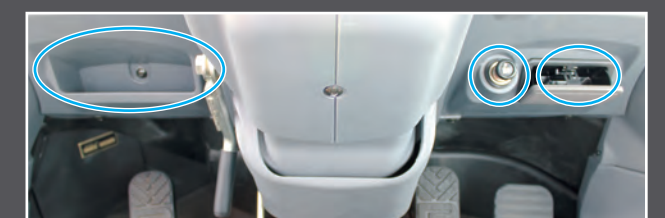

Glove compartment, cigarette lighter and ashtray

Simplified Maintenance with Proven Support System

Hitachi Support Chain offers a comprehensive suite of support services for customers.

PICK UP Simplified Maintenance

The engine cover swings up to provide a wide service space. Filters are concentrated for easy inspection and servicing from the ground.

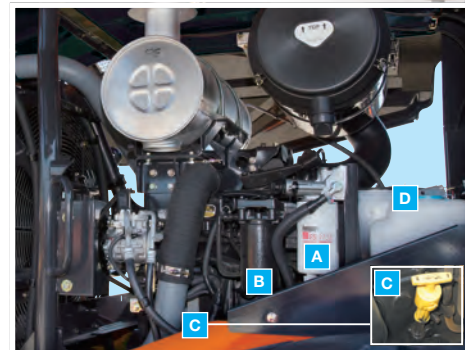

- A Fuel pre-filter
- B Main fuel filter
- C Engine oil gauge
- D Window washer tank

Robust Frame

The main frame and its joints are thoroughly strengthened. The box-section structure is adopted around center pins, where concentrated forces are applied, for reinforcement. Frame plate thicknesses are optimally determined by 3D stress analysis.



Robust frame

Wide Fin Pitch Radiator (Optional)

Wide fin pitch radiator is available for use in dusty environments, where there are large amounts of airborne debris, to avoid dust clogging and overheating as a result. Air blowing is easy and simple.

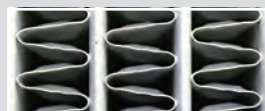

Standard fin pitch radiator

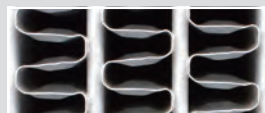

Wide fin pitch radiator

NEW Automatic Reversible Cooling Fan (Optional) to Reduce Dust Deposits



The automatic reversible cooling fan is available to keep the radiator clean at all times. The cooling fan is automatically self-reversed every 30 minutes to blow dust off the radiator. The cover swings up for efficient air blowing.

Parts and Service

Parts

Hitachi Global Online Network, a parts supply system, is linked with CPD (Central Parts Depot), overseas depots and dealers abroad to deliver on-line parts information, including in-stock parts, order receptions, shipments and delivery period of over one million parts and components.

Genuine Hitachi Parts

Genuine Hitachi parts, meeting Hitachi stringent quality standards, are guaranteed according to Hitachi warranty standards. The use of genuine Hitachi parts, including engine, fuel, hydraulic oil and filters, may slash running costs, and extend machine life.

Service

ConSite

ConSite is a full-package service menu which is designed for Hitachi's machines used around the world. We closely monitor and support each machine working at each job site from various aspects, ensuring the best-tuned machines that are accommodated for the site condition and meet your specific needs.

Technical Training

On-site servicing matters despite locations to keep the machine at peak performance and reduce downtime. Technical Training Center (TTC), located in Japan, educates and trains service technicians and service support personnel coming from Hitachi dealers and factories on the globe according to the international training programs.



SPECIFICATIONS

ENGINE

Model	CUMMINS QSB6.7
Type	4-cycle water-cooled, direct injection
Aspiration	Turbocharger and intercooled
No. of cylinders	6
Maximum power	
SAE J1995/ISO14396, gross.....	128 kW (172 HP) at 2 200 rpm
SAE J1349/ISO 9249, net	125 kW (168 HP) at 2 200 rpm
Rated power	
SAE J1995, gross.....	128 kW (172 HP) at 2 200 rpm
Maximum torque	763 Nm at 1 400 min ⁻¹ (rpm)
Bore and stroke	107 mm X 124 mm
Piston displacement	6.690 L
Batteries	2 X 12 V
Air cleaner	Two element dry type with restriction indicator

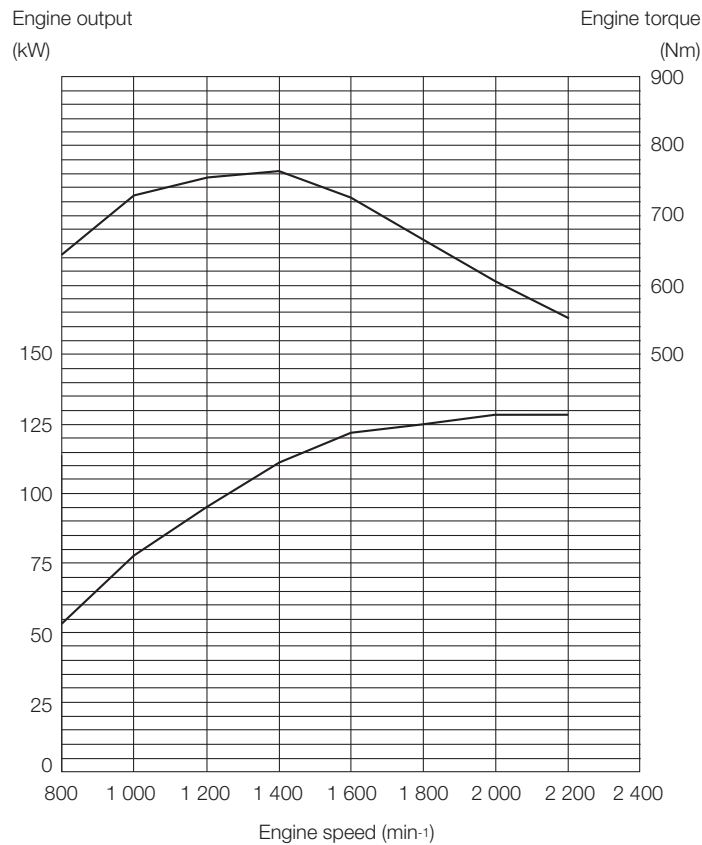

POWER TRAIN

Transmission	Torque converter, countershaft type powershift with computer-controlled automatic shift and manual shift features included.
Torque converter	Three element, single stage, single phase
Main clutch	Wet hydraulic, multi-disc type
Cooling method	Forced circulation type
Travel speed* Forward / Reverse	
1st	5.9 / 6.1 km/h (5.8 / 6.1 km/h)
2nd	11.5 / 11.8 km/h (12.0 / 12.6 km/h)
3rd	17.0 / 26.0 km/h (18.1 / 27.7 km/h)
4th	24.8 km/h (26.4 km/h)
5th	38.5 km/h (38.5 km/h)
*With 20.5-25-12PR (L3) tires	
() : Data at Power Mode	

AXLE AND FINAL DRIVE

Drive system	Four-wheel drive system
Front & rear axle	Semi-floating
Front	Fixed to the front frame
Rear	Trunnion support
Reduction and differential gear	Two stage reduction with conventional differential
Oscillation angle	Total 24° (+12°, -12°)
Final drives	Heavy-duty planetary, mounted outboard

TIRES

Tire size	20.5-25-12PR (L3)
Optional	Refer to standard & optional equipment list

BRAKES

Service brakes	Outboard mounted fully hydraulic 4 wheel wet disc brake. Front & rear independent brake circuit
Parking brakes	Spring applied, hydraulically released, dry disc type with external output shaft

STEERING SYSTEM

Type	Articulated frame steering
Steering angle	Each direction 40° ; total 80°
Cylinders	Double-acting piston type
No. x Bore x Stroke	2 x 70 mm x 442 mm

HYDRAULIC SYSTEM

Arm and bucket are controlled by independent control lever	
Arm controls	Four position valve ; Raise, hold, lower, float
Bucket controls with automatic bucket return-to-dig control	
.....	Three position valve ; Roll back, hold, dump
Main pump (Serve as steering pump)	
.....	Variable Displacement Axial Plunger Pump
Maximum flow	210 L/min at 2 200 min ⁻¹ (rpm)
Maximum pressure ..	27.4 MPa
Fan pump	
.....	Fixed Displacement Gear Pump
Maximum flow	80.5 L/min at 2 200 min ⁻¹ (rpm)
Maximum pressure ..	14.7 MPa
Hydraulic cylinders	
Type	Double acting type
No. x Bore x Stroke ...	Arm : 2 x 125 mm x 765 mm
	Bucket : 1 x 150 mm x 495 mm
Filters	Full-flow 15 micron return filter in reservoir
Hydraulic cycle times	
Lift arm raise	5.9 s (5.7 s)
Lift arm lower	3.6 s (3.6 s)
Bucket dump	1.4 s (1.3 s)
Total	10.9 s (10.6 s)
() : Data at Power Mode	

SERVICE REFILL CAPACITIES

Fuel tank	235 L
Engine coolant	25 L
Engine oil	25 L
Torque converter & transmission	30 L
Front axle differential & wheel hubs	34 L
Rear axle differential & wheel hubs	35 L
Hydraulic oil tank	100 L

DIMENSIONS & SPECIFICATIONS

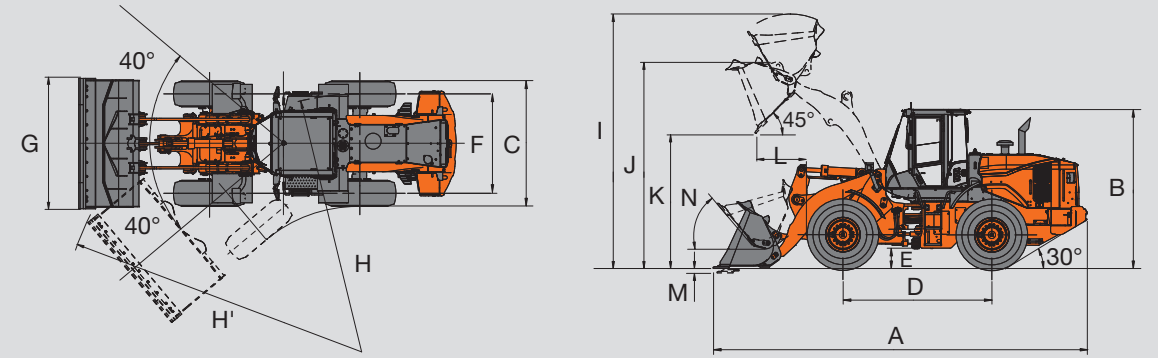

Bucket type		Standard arm						High lift Arm	
		General purpose				Rock bucket	General purpose		
		Bolt-on cutting edge		Bolt-on teeth		Bolt-on teeth	Bolt-on cutting edge		
Bucket capacity	ISO heaped ISO struck	m ³	2.8 2.4	3.0 2.6	3.3 2.9	2.7 2.3	2.9 2.5	2.2 1.9	2.4 2.0
A Overall length		mm	7 790	7 840	7 920	7 940	7 990	7 820	8 250
B Overall height		mm				3 280			
C Width over tires		mm				2 610			
D Wheel base		mm				3 100			
E Ground clearance		mm				395			
F Tread		mm				2 050			
G Bucket width		mm				2 690			
H Turning radius (Centerline of outside tire)		mm				5 300			
H' Loader clearance radius, bucket in carry position		mm	6 200	6 210	6 230	6 240	6 260	6 210	6 370
I Overall operating height		mm	5 290	5 340	5 420	5 290	5 340	5 230	5 580
J Height to bucket hinge pin, fully raised		mm				3 920			4 320
K Dumping clearance 45 degree, full height		mm	2 800	2 760	2 710	2 690	2 660	2 770	3 290
L Reach, 45 degree dump, full height		mm	1 070	1 100	1 160	1 150	1 190	1 070	1 130
M Digging depth (Horizontal digging angle)		mm	100	100	100	110	110	110	170
N Max. roll back at carry position		deg				50			
Static tipping load *	Straight	kg	11 760	11 710	11 630	11 940	11 890	11 460	9 990 **
	Full 40 degree turn	kg	10 130	10 080	10 010	10 300	10 260	9 820	8 590 **
Breakout force		kgf	11 970	11 450	10 740	13 040	12 430	14 430	12 310
		kN	117	112	105	128	122	141	121
Operating weight (with ROPS/FOPS cab) *		kg	14 640	14 680	14 730	14 580	14 610	15 070	15 060 **

Note: All dimensions, weight and performance data based on ISO 6746-1:1987, ISO 7131:2009 and ISO 7546:1983

: Static tipping load and operating weight marked with include 20.5-25-12PR(L3) tires (No ballast) with lubricants, full fuel tank, 1 350kg counter weight, ROPS cab and operator.

** : High lift Arm use the 1 660 kg counter weight. Others are same as above.

Machine stability and operating weight depend on counterweight, tire size and other attachments.

WEIGHT CHANGE

Option item	Operating weight (kg)	Tipping load (kg)		Overall width (mm) (outside tire)	Overall height (mm)	Overall length (mm)
		Straight	Full turn			
Tire	20.5-25-12PR (L3)	±0	±0	±0	±0	±0
	20.5-25-16PR (L3)	+30	+20	+10	±0	±0
	20.5R25 (L3)	+180	+140	+120	+20	+10
	20.5R25 (L5)	+610	+460	+400	+40	+30
Belly guard	+160	+90	+80	-	-	-
1 660 kg Counter weight	+310	+790	+700	-	-	-

BUCKET SELECTION GUIDE

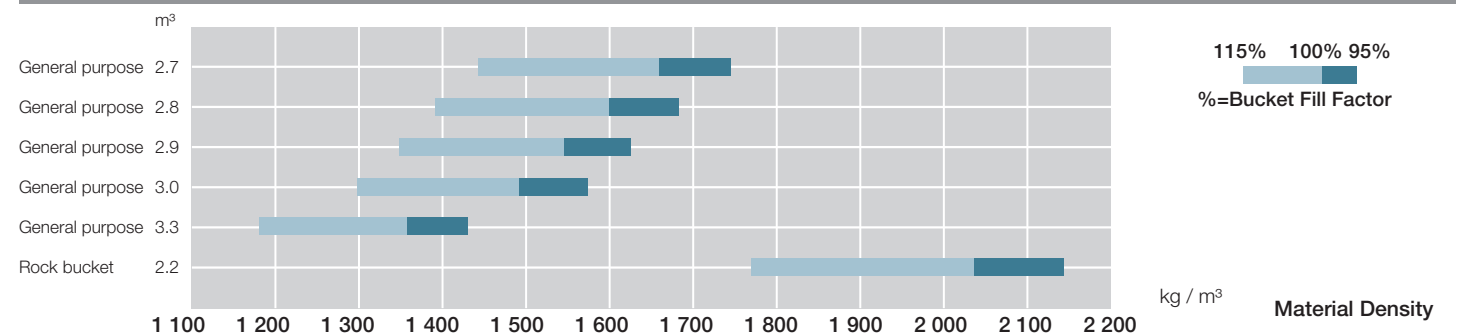

EQUIPMENT

● Standard equipment ○ Optional equipment

OPERATOR'S STATION

Adjustable steering column	●
Ashtray, cigar lighter	●
Audio	
AM/FM radio	●
AM/FM radio with AUX for digital audio player	○
Auto control air conditioner	
with single intake filter	●
with double intake filter	○
Cab	
ROPS (ISO3471), FOPS (ISO3449)	●
Coat hook	●
Front/Rear defroster	●
Glove compartment	●
Rear view camera & monitor	○
Rear view mirrors	
Inside (2)	●
Outside (2)	●
Retractable seat belt, 50mm	●
Rubber floor mat	●
Seat	
Mechanical suspension seat: fabric, high back, adjustable for armrest angle, fore-aft position, reclining angle and weight-height.	●
Air suspension seat with headrest and heater: fabric, high back, adjustable for armrest angle, damper, fore-aft position, headrest height and angle, inclination of the seat, lumbar support, reclining angle, seat depth and weight-height.	○
Storage	
Cup holder	●
Digital audio player holder	●
Document holder	●
Hot & cool box	●
Seatback pocket	●
Sun visor	●
Textured steering wheel with spinner knob	●
Safety glass (tempered)	●
Windshield washer front and rear	●
Windshield wipers front and rear	●

ELECTRICAL SYSTEM

Backup alarm	●
Batteries	
Standard batteries (114AH-765A)	●
Large capacity batteries (147AH-930A)	○
Battery disconnect switch	○
12V power outlet	○

COOLING SYSTEM

Fan	
Cooling fan with heat sensing	●
Automatic reversible cooling fan with heat sensing	○
Fan guard	●
Radiator	
Standard fin pitch radiator	●
Wide fin pitch radiator	○

LIGHTS

Brake & tail lights	●
Clearance lights	●
Headlights	●
Rotating lamp	○
Turn signals with hazard switch	●
Work lights	
Front lights on cab (2)	●
Rear lights on rear grille side cover (2)	●
Additional front lights on cab (2)	○
Rear lights on cab (2)	○

POWER TRAIN

Automatic transmission with load sensing system	●
Clutch cut position switch	●
Differential	
Conventional differential	●
LSD (Limited Slip Differential, front)	○
DSS (Down Shift Switch)	●
Forward/Reverse lever	●
Power mode switch	●
Quick power switch	●
Travel mode selector (Auto1-Auto2)	●
1st speed fixed switch	●

ENGINE

Air intake	
Rain cap	●
Pre-cleaner (Sy-Klone)	○
Pre-cleaner (Bowl type)	○
Air filter double elements	●
Cartridge-type engine oil filter	●
Cartridge-type fuel pre-filter	●
Cartridge-type fuel main filter	●
Engine oil remote drain	●

MONITORING SYSTEM

Gauge: coolant temperature, fuel, transmission oil temperature	●
Indicator lights: air filter restriction, brake oil low pressure, clearance lights, control lever lock, discharge warning, emergency steering, engine warning, fan reverse, fuel filter restriction, forward/reverse selector switch, high beam, hydraulic oil temperature, maintenance, parking brake, power mode, preheat, seat belt, service, transmission oil temperature, transmission warning, turn signals, water separator, work lights	●
LCD monitor display: clock, ECO, F-N-R/Shift position, hold, hour meter, odometer, replacement intervals, ride control, speedometer	●
Warning lights: brake oil low pressure, engine oil low pressure, overheat, steering oil low pressure	●

BRAKE SYSTEM

Front & rear independent brake circuit	●
Outboard mounted fully hydraulic 4 wheel wet disc	●
Pedal	
Single brake pedal	●
Double (LH & RH) brake pedal	○
Spring-set/Hydraulic-released parking brake	●

HYDRAULIC SYSTEM

Bucket auto leveler (Automatic return to dig control)	●
Control lever	
for 2 spools control valve	
2 levers	●
Multifunction lever (MF lever)	○
for 3 spools control valve	
MF lever & AUX lever for 3rd function	○
2 levers & AUX lever for 3rd function	○
- Inside layout pattern (3rd - bucket - liftarm)	○
- Outside layout pattern (Bucket - liftarm - 3rd)	○
Control lever lock switch	●
Dual lift arm auto leveler	○
Hydraulic filters	●
Lift arm float system	●
Reservoir sight gauge	●
Ride control system (OFF-AUTO type)	○

TIRES

20.5-25-12PR (L3)	●
20.5-25-16PR (L3)	○
20.5R25 (L3)	○

MISCELLANEOUS

Articulation lock bar	●
Belly guard (Bolt on type)	○
Bucket cylinder guard	○
Counter weight	
1 350 kg counter weight	●
1 660 kg counter weight	○
Drawbar with locking pin	●
Emergency steering	○
Fenders	
for 20.5-25-12PR	
Front & half covered rear fenders	●
Front & full covered rear fenders with mud flaps	○
Front & half covered rear fenders with mud flaps	○
Global e-service	●
Lift arm	
Standard lift arm	●
High lift arm	○
Lift & tie down hooks	●
On board information controller	●
Pilfer proof	
Battery cover with locking bracket	●
Lockable engine cover	●
Lockable fuel refilling cap	●

Anti-vandal protection, includes lockable engine enclosure, and fuel fill
Standard and optional equipment may vary by country, so please consult your Hitachi dealer for details.



Built on the foundation of superb technological capabilities, Hitachi Construction Machinery is committed to providing leading-edge solutions and services to contribute as a reliable partner to the business of customers worldwide.



Hitachi Environmental Vision 2050

Our Environmental Vision envisions a low-carbon society; a resource efficient society; a harmonized society with nature. To achieve such a sustainable society, we have established a set of long-term environmental targets called Hitachi Environmental Innovation 2050.

Reducing Environmental Impact by New ZW

Hitachi makes a green way to cut carbon emissions for global warming prevention according to LCA*. New ZW utilizes many technological advances, including the new standard mode which optimizes fuel efficiency. Hitachi has long been committed to recycling of components, such as aluminum parts in radiators and oil coolers. Resin parts are marked for recycling.

*Life Cycle Assessment – ISO 14040

Before using a machine with a satellite communication system, please make sure that the satellite communication system complies with local regulations, safety standards and legal requirements. If not so, please make modifications accordingly.

These specifications are subject to change without notice. Illustrations and photos show the standard models, and may or may not include optional equipment, accessories, and all standard equipment with some differences in color and features. Before use, read and understand the Operator's Manual for proper operation.